

**TD 434**

**TD 484**

**TD 534**

CHASSIS  
MANICO  
COMANDI  
DOTAZIONE VITERIE

DECK  
HANDLE  
CONTROLS  
SCREWS OUTFITS

CHÂSSIS  
MANCHERON  
COMMANDES  
DOTATION VISSERIE

GEHÄUSE  
HOLM  
BETÄTIGUNGEN  
SCRAUBENSATZ

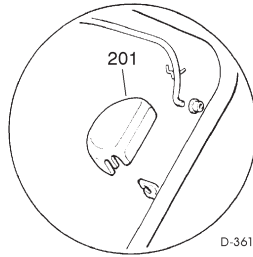

D-3615/E

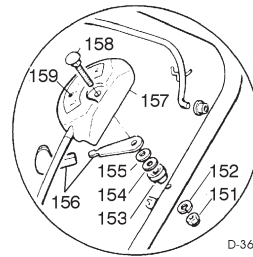

D-3615/D

SPARE PARTS CATALOGUE

ERSATZTEILKATALOG

GB

D

CATALOGO DELLE PARTI  
DI RICAMBIO

CATALOGUE DES PIÈCES  
DE RECHANGE

I

F

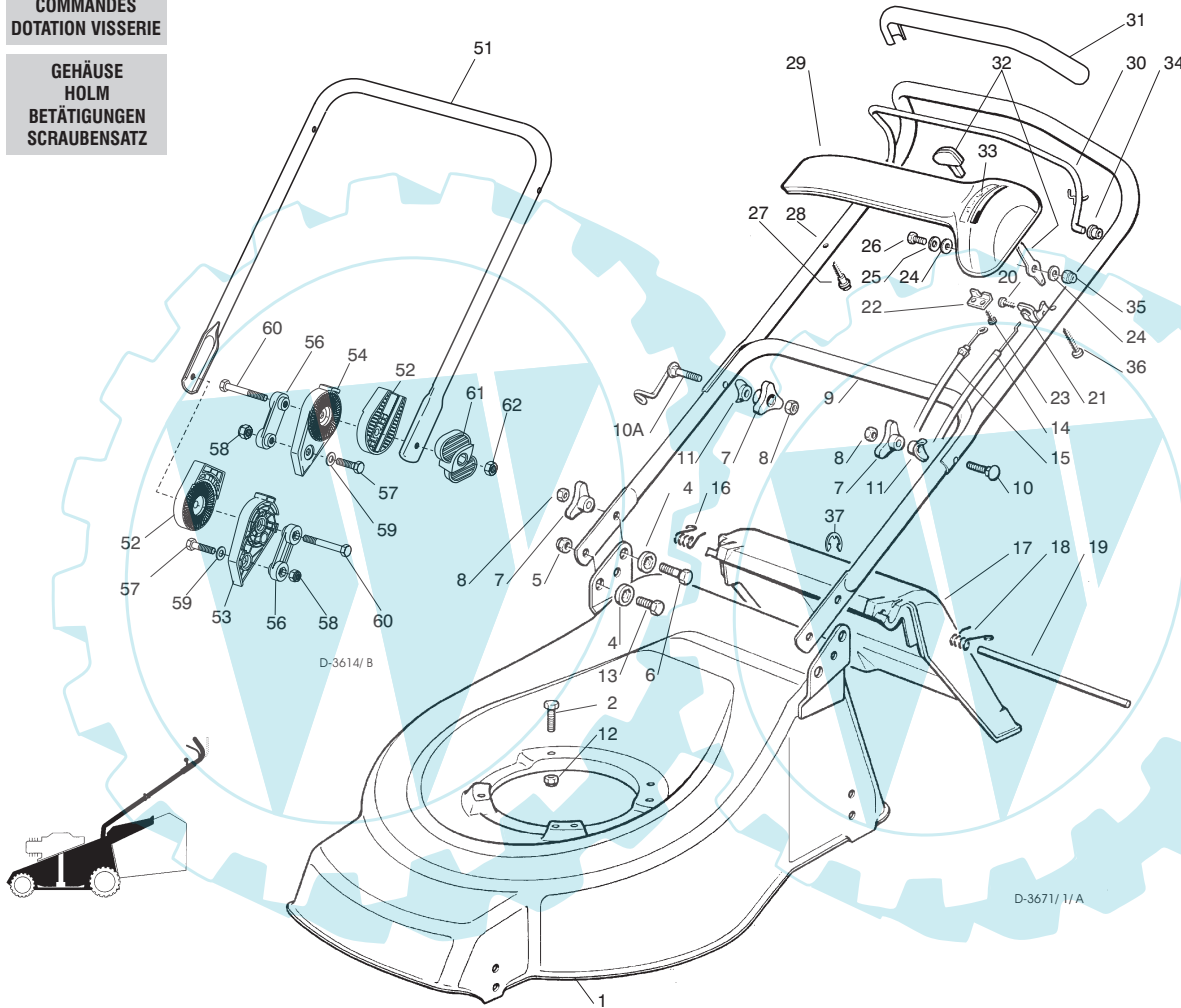

D-3614/B

D-3671/1/A

T-3671/1/A

Pos. Nr.	Codice Code Kodex	Q.tà Q.ty-Q.tè Menge	Descrizione	Description	Description	Beschreibung
1		1	CHASSIS	DECK	CHÂSSIS	GEHÄUSE
—	81001338/0	1	ROSSO TD 434	RED TD 434	OUGE TD 434	ROTES TD 434
—	81001348/0	1	GIALLO TD 434	YELLOW TD 434	JAUNE TD 434	GELBES TD 434
—	81001370/0	1	VERDE TD 434	GREEN TD 434	VERT TD 434	GRÜNES TD 434
—	81001339/0	1	ROSSO TD 484	RED TD 484	OUGE TD 484	ROTES TD 484
—	81001350/0	1	GIALLO TDL 484	YELLOW TD 484	JAUNE TD 484	GELBES TD 484
—	81001372/0	1	VERDE TD 484	GREEN TD 484	VERT TD 484	GRÜNES TD 484
—	81001735/1	1	ROSSO TD 534	RED TD 534	ROUGE TD 534	ROTES TD 534
—	81001736/1	1	GIALLO TD 534	YELLOW TD 534	JAUNE TD 534	GELBES TD 534
—	81001737/1	1	VERDE TD 534	GREEN TD 534	VERT TD 534	GRÜNES TD 534
2			VITE	SCREW	VIS	SCHRAUBE
—	12793700/0	3/2	(M8X30)	(M8X30)	(M8X30)	(M8X30)
—	12691800/0	0/1	(M8X60)	(M8X60)	(M8X60)	(M8X60)
4	22041955/0	4	BUSSOLA	BUSH	DOUILLE	BUCHSE
5	12155000/0	2	DADO	NUT	ECROU	MUTTER
6	12793700/0	2	VITE	SCREW	VIS	SCHRAUBE
7	22399900/0	4	MANOPOLINA	KNOB	POIGNÉE	GRIFF
8	12293200/0	4	DADO	NUT	ECROU	MUTTER

Pos. Nr.	Codice Code Kodex	Q.tà Q.ty-Q.tè Menge	Descrizione	Description	Description	Beschreibung
9	81006512/0	1	PARTE INF. MANICO	LOWER HANDLE	PARTIE INF. MANCHERON	UNTERHOLM
10	12819201/0	1	VITE	SCREW	VIS	SCHRAUBE
10A	81003801/0	1	MOLLA GUIDA	SPRING	RESSORT	FEDER
11	22680006/1	2	RONDELLA	WASHER	RONDELLE	SCHEIBE
12	12293201/0	3/2	DADO	NUT	ECROU	MUTTER
—	12155000/0	0/1	DADO	NUT	ECROU	MUTTER
13	12792610/0	2	VITE	SCREW	VIS	SCHRAUBE
14	81007160/0	1	CAVO ACCELERATORE	THROTTLE CABLE	CABLE ACCELERATEUR	BESCHLEUNIGER KABEL
15	—	—	CAVO FRENO MOTORE	THREAD MOTOR BRAKE	CABLE FREIN MOTEUR	MOTORBREMSEKABEL
—	81000633/0	1	TD 434 (QUANTUM XM)	TD 434 (QUANTUM XM)	TD 434 (QUANTUM XM)	TD 434 (QUANTUM XM)
—	81000629/1	1	TD 434-484 (TECUMSEH)	TD 434-484 (TECUMSEH)	TD 434-484 (TECUMSEH)	TD 434-484 (TECUMSEH)
—	81000631/0	1	TD 484 (QUANTUM XM-ES 40)	TD 484 (QUANTUM XM-ES 40)	TD 484 (QUANTUM XM-ES 40)	TD 484 (QUANTUM XM-ES 40)
—	81000625/0	1	TD 484 (SPRINT 375/ QUATTRO)	TD 484 (SPRINT 375/ QUATTRO)	TD 484 (SPRINT 375/ QUATTRO)	TD 484 (SPRINT 375/ QUATTRO)
—	81000641/0	1	TD 484 (HONDA GCV 135/ 160)	TD 484 (HONDA GCV 135/ 160)	TD 484 (HONDA GCV 135/ 160)	TD 484 (HONDA GCV 135/ 160)
—	81000642/0	1	TD 534 (QUANTUM XM-ES 40)	TD 534 (QUANTUM XM-ES 40)	TD 534 (QUANTUM XM-ES 40)	TD 534 (QUANTUM XM-ES 40)
—	81000643/0	1	TD 534 (SPRINT 375/ QUATTRO)	TD 534 (SPRINT 375/ QUATTRO)	TD 534 (SPRINT 375/ QUATTRO)	TD 534 (SPRINT 375/ QUATTRO)
—	81000644/0	1	TD 534 (TECUMSEH)	TD 534 (TECUMSEH)	TD 534 (TECUMSEH)	TD 534 (TECUMSEH)
—	81000640/0	1	TD 534 (HONDA GCV 135/ 160)	TD 534 (HONDA GCV 135/ 160)	TD 534 (HONDA GCV 135/ 160)	TD 534 (HONDA GCV 135/ 160)
16	22450410/1	1	MOLLA DX	RIGHT SPRING	RESSORT DROITE	RECHTE FEDER
17	22600046/1	1	PARASASSI	STONE-GUARD	PARE-PIERRES	PRALLBLECH
18	22450420/1	1	MOLLA SX	LEFT SPRING	RESSORT GAUCHE	LINKE FEDER
19	22517906/1	1	PERNO	PIN	PIVOT	BOLZEN
20	12728518/0	1	VITE	SCREW	VIS	SCHRAUBE
21	22806612/0	1	SUPPORTO	SUPPORT	SUPPORT	HALTER
22	22981467/0	1	PIASTRINA	PLAQUE	PLAQUETTE	PLATTE
23	12735105/0	2	VITE	SCREW	VIS	SCHRAUBE
24	12523040/0	2	RONDELLA	WASHER	RONDELLE	SCHEIBE
25	12530060/0	1	RONDELLA ELASTICA	SPRING WASHER	RONDELLE ELASTIQUE	ELASTISCHE SCHEIBE
26	12791500/0	1	VITE	SCREW	VIS	SCHRAUBE
27	22943006/0	1	VITE	SCREW	VIS	SCHRAUBE
28	81007018/0	1	PARTE SUP. MANICO	UPPER HANDLE	PARTIE SUP. MANCHERON	OBERHOLM
29	—	—	CRUSCOTTO	DASH BOARD	CONSOLE	KONSOLE
—	22120154/0	1	ROSSO	RED	ROUGE	ROTE
—	22120152/0	1	GIALLO	YELLOW	JAUNE	GELBE
—	22120158/0	1	NERO	BLACK	NOIRE	SCHWARZE
30	81003291/2	1	LEVA FRENO MOTORE	BRAKE LEVER	LEVIER FREIN MOTEUR	MOTORBREMSEHEBEL
31	—	—	IMPUGNATURA MANICO	HANDGRIP	POIGNÉE	HANDGRIFF
—	22291050/0	1	NERA	BLACK	NOIRE	SCHWARZER
—	22291051/0	1	ROSSA	RED	ROUGE	RÖTER
—	22291052/0	1	GIALLA	YELLOW	JAUNE	GELBER
32	81007280/2	1	ASS. LEVA + MANOPOLINA	LEVER + KNOB ASS. Y	ENS. LEVIER + POIGNÉE	HEBEL + GRIFF SATZ
33	—	—	ETICHETTA (TECUMSEH-HONDA)	LABEL (TECUMSEH-HONDA)	ETIQUETTE (TECUMSEH-HONDA)	ETIKETTE (TECUMSEH-HONDA)
—	14356743/0	1	(B&S)	(B&S)	(B&S)	(B&S)
—	14356744/0	1	(B&S)	(B&S)	(B&S)	(B&S)
34	22041966/0	2	BOCCOLA	BUSH	DOUILLE	BUCHSE
35	12154510/0	1	DADO	NUT	ECROU	MUTTER
36	12728460/0	1	VITE	SCREW	VIS	SCHRAUBE
37	12000930/0	1	ANELLO ELASTICO	SNAP RING	ANNEAU RESSORT	SPRENGRING

—	81008614/1	1	DOTAZIONE VITERIA	SCREWS OUTFIT	DOTATION VISSERIE	SCHRAUBEN SATZ
—	81008609/0	1	DOTAZIONE CRUSCOTTO	DASH-BOARD OUTFIT	DOTATION CONSOLE	KONSOLE SATZ

**VARIANTE REGOLAZIONE MANICO**
**HANDLE ADJUSTMENT VARIANT**
**VARIANTE REGLAGE POIGNEE**
**GRIFFEINSTELLVARIANTE**

T-3615/ B

51	81006510/0	1	PARTE INF. MANICO	LOWER HANDLE	PARTIE INF. MANCHERON	UNTERHOLM
52	22785081/0	2	SUPPORTO ESTERNO	EXTERNAL SUPPORT	SUPPORT EXTERNE	AUßERE HALTERUNG
53	22785082/0	1	SUPPORTO INTERNO DX	R. INTERNAL SUPPORT	SUPPORT INTERNE DROIT	INNERE HALTERUNG RECHTS
54	22785083/1	1	SUPPORTO INTERNO SX	L. INTERNAL SUPPORT	SUPPORT INTERNE GAUCHE	INNERE HALTERUNG LINKS
56	22551575/0	2	PIASTRINA INTERNA	INSIDE PLAQUE	PLAQUETTE INTERNE	INNERE PLATTE
57	12793701/0	2	VITE	SCREW	VIS	SCHRAUBE
58	12155000/0	2	DADO	NUT	ECROU	MUTTER
59	12521350/0	2	RONDELLA	WASHER	RONDELLE	SCHEIBE
60	12691810/0	2	VITE	SCREW	VIS	SCHRAUBE
61	22399803/0	2	MANOPOLINA	KNOB	POIGNÉE	GRIFF
62	12293202/0	2	DADO	NUT	ECROU	MUTTER
—	81008623/0	1	DOTAZ. VITERIA	SCREWS OUTFIT	DOTATION VISSERIE	SCHRAUBEN SATZ

**VARIANTE ACCELERATORE**
**THROTTLE VARIANTS**
**VARIANTES COMMANDE D'ACCELERATION**
**ÄNDERUNGEN AUF GASHEBEL**

T-3616/ D

151	12291000/0	1	DADO	NUT	ECROU	MUTTER
152	12581500/0	1	GROWER	GROWER	GROWER	FEDERRING
153	22171005/0	1	DISTANZIALE	SPACER	ENTRETOISE	DISTANZRING
154	12521360/0	1	RONDELLA	WASHER	RONDELLE	SCHEIBE
155	12508100/0	1	RONDELLA ELASTICA	SPRING WASHER	RONDELLE ELASTIQUE	ELASTISCHE SCHEIBE
156	81007279/0	1	ASS. LEVA+MANOPOLINA	LEVER+KNOB ASS.Y	ENS. LEVIER+POIGNEE	HEBEL+GRIFF SATZ
157	81007080/0	1	ASSIEME ACCELERATORE	TROTTLER UNIT ASS.Y	ENS. ACCELERATEUR	BESCHLEUNIGER SATZ
158	12815000/0	1	VITE	SCREW	VIS	SCHRAUBE
159	—	—	ETICHETTA (TECUMSEH-HONDA)	LABEL (TECUMSEH-HONDA)	ETIQUETTE (TECUMSEH-HONDA)	ETIKETTE (TECUMSEH-HONDA)
—	14356702/0	1	(B&S)	(B&S)	(B&S)	(B&S)
—	14356703/0	1	(B&S)	(B&S)	(B&S)	(B&S)

Pos. Nr.	Codice Code Kodex	Q.tà Q.ty-Q.tè Menge	Descrizione	Description	Description	Beschreibung
----------	-------------------	----------------------	-------------	-------------	-------------	--------------

T-3615/E

VARIANTE REGIME FISSO	FIXED SPEED VARIANTS	VARIANTES POUR MODELE À REGIME FIXE	ÄNDERUNGEN FÜR MODELLE MIT FIXIRTER DREHZAHL
-----------------------	----------------------	-------------------------------------	--

201	22601000/0	PROTEZIONE	PROTECTION	PROTECTION	SCHUTZ
-----	------------	------------	------------	------------	--------

**RUOTE E REGOLAZIONE**

**WHEELS AND HEIGHT ADJUSTING**

**ROUES ET REGLAGE HAUTER DE COUPE**

**RÄDER UND SCHNITTHÖHEVERSTELLUNG**

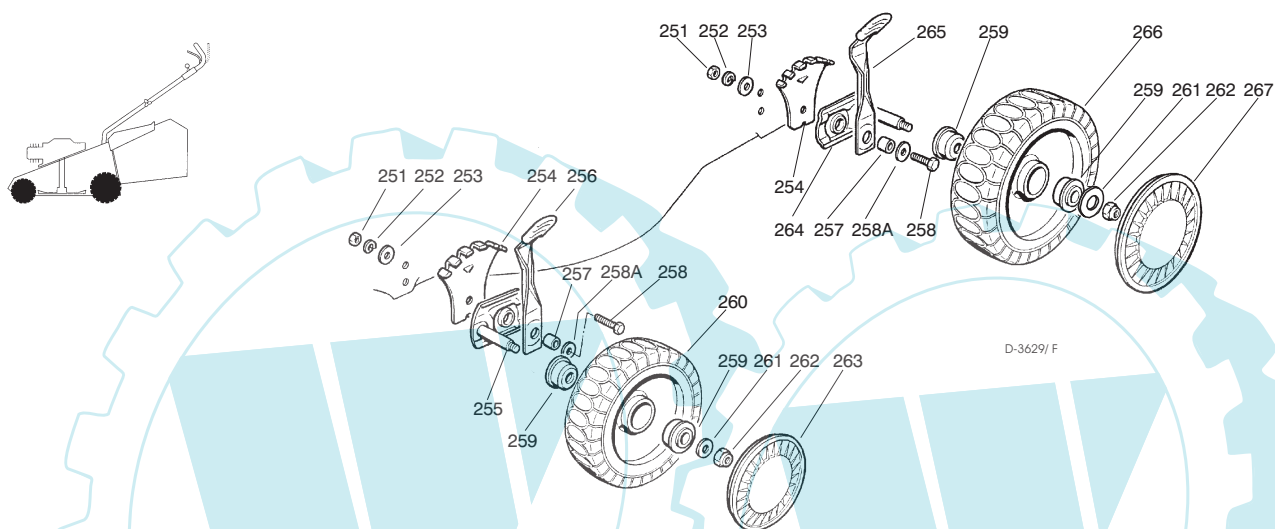

T-3671/F

251	12293200/0	4	DADO	NUT	ECROU	MUTTER
252	12583500/0	4	GROWER	GROWER	GROWER	FEDERRING
253	12523070/0	4	RONDELLA	WASHER	RONDELLE	SCHEIBE
254	22735547/0	4	SETTORE REGOLAZIONE	ADJUSTMENT SECTOR	SECTEUR REGLAGE	VERSTELLUNGSEKTOR
255	81005082/0	2	SUPPORTO RUOTA	WHEEL SUPPORT	SUPPORT ROUE	RADHALTER
256	81003285/1	2	LEVA REGOLAZIONE	ADJUSTMENT LEVER	LEVIER REGLAGE	VERSTELLUNGHEBEL
257	22171001/0	4	DISTANZIALE	SPACER	ENTRETOISE	DISTANZRING
258	12793701/0	4	VITE	SCREW	VIS	SCHRAUDE
258A	12521350/0	4	RONDELLA	WASHER	RONDELLE	SCHEIBE
259	22034508/0	8	BOCCOLA	BUSH	DOUILLE	BUCHSE
260	81007317/0	2	RUOTA SCOLPITA Ø 170	KNOBBLY WHEEL Ø 170	ROUE SCULPTEE Ø 170	RAD M. STOLLENPR. Ø 170
261	12523060/0	4	RONDELLA	WASHER	RONDELLE	SCHEIBE
262	12155000/0	4	DADO	NUT	ECROU	MUTTER
263			COPRIMOZZO	HUB CAP	COUVRE-MOYEU	RADKAPPE
—	22110282/0	2	BIANCO	WHITE	BLANC	WEIßE
—	22110288/0	2	GIALLO	YELLOW	JAUNE	GELB
—	22110290/0	2	ROSSO	RED	ROUGE	ROTE
264	81005084/0	2	SUPPORTO RUOTA	WHEEL SUPPORT	SUPPORT ROUE	RADHALTER
265	81003286/0	2	LEVA REGOLAZIONE	ADJUSTMENT LEVER	LEVIER REGLAGE	VERSTELLUNGHEBEL
266	81007318/1	2	RUOTA SCOLPITA Ø 210	KNOBBLY WHEEL Ø 210	ROUE SCULPTEE Ø 210	RAD M. STOLLENPR. Ø 210
267			COPRIMOZZO	HUB CAP	COUVRE-MOYEU	RADKAPPE
—	22110281/0	2	BIANCO	WHITE	BLANC	WEIßE
—	22110287/0	2	GIALLO	YELLOW	JAUNE	GELB
—	22110289/0	2	ROSSO	RED	ROUGE	ROTE

Pos. Nr.	Codice Code Kodex	Q.tà Q.ty-Q.tè Menge	Descrizione	Description	Description	Beschreibung
----------	-------------------	----------------------	-------------	-------------	-------------	--------------

- GRUPPO COLTELLO**
- BLADE ASS.Y**
- GROUPE LAME**
- MESSERSATZ**

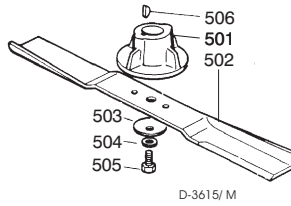
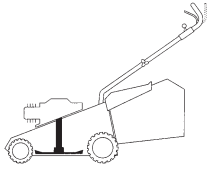

D-3615/ M

T-3623/ M

501	22463012/ 1	1	MOZZO	HUB	MOYEU	HALTER
502			COLTELLO	BLADE	LAME	MESSER
—	81004341/ 2	1	STANDARD 41 cm.	STANDARD 41 cm.	STANDARD 41 cm.	STANDARD 41 cm.
—	81004396/ 0	1	ALETTATO 41 cm.	WINGED 41 cm.	AILETTÉE 41 cm.	FLÜGEL 41 cm
—	81004346/ 2	1	STANDARD 46 cm.	STANDARD 46 cm.	STANDARD 46 cm.	STANDARD 46 cm.
—	81004397/ 0	1	ALETTATO 46 cm.	WINGED 46 cm.	AILETTÉE 46 cm.	FLÜGEL 46 cm
—	81004381/ 0	1	STANDARD 51 cm.	STANDARD 51 cm.	STANDARD 51 cm.	STANDARD 51 cm.
—	81004398/ 0	1	ALETTATO 51 cm.	WINGED 51 cm.	AILETTÉE 51 cm.	FLÜGEL 51 cm
503	22160400/ 0	1	DISCO ELASTICO	ELASTIC WASHER	RONDELLE ELASTIQUE	ELASTISCHE SCHEIBE
504	12523080/ 0	1	RONDELLA	WASHER	RONDELLE	SCHEIBE
505	12735698/ 0	1	VITE	SCREW	VIS	SCHRAUBE
506	12139100/ 0	1	LINGUETTA	FEATHER	CLAVETTE	KEIL

- SACCO RACCOGLIERBA**
- GRASS-CATCHER**
- BAC DE RAMASSAGE**
- GRASFANGKORB**

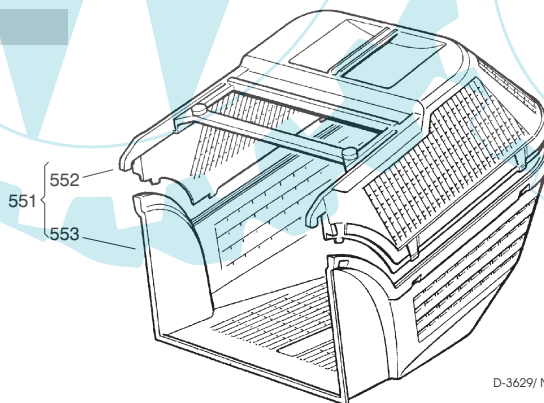
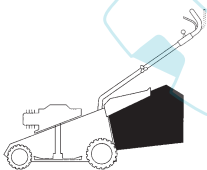

D-3629/ N

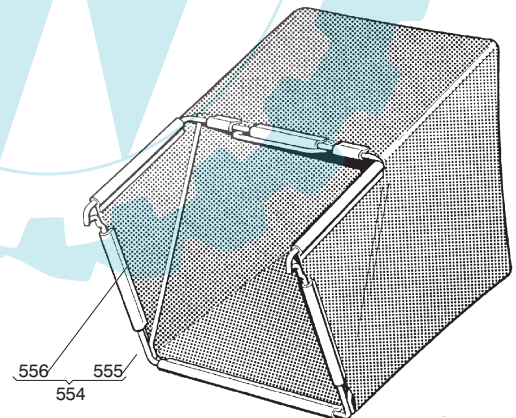

T-3629/ N

551	94004000/ 1	1	SACCO COMPLETO	COMPLETE GRASS-BOX	SAC COMPLET	KOMPLETTER KORB
552	22486073/ 0	1	PORTE SUP. SACCO	UPPER GRASS BOX	PARTIE SUP. SAC	OBERKORB
553	22486074/ 0	1	PORTE INF. SACCO	LOWER GRASS BOX	PARTIE INF. SAC	UNTERKORB
554	94005000/ 0	1	ASS. SACCO IN TELA	CANVASS GRASSCATCHER	ENSEMBLE SAC EN TOILE	KOMPLETTER SACK
555	81006418/ 0	1	TELAIO	CHASSIS	CHÂSSIS	RAHMEN
556	81002105/ 2	1	TELA SACCO	FABRIC BOX	TOILE POUR SAC	TUCK FÜR SACK